

Right Angle Crimp Type Plug - Captivated Contact

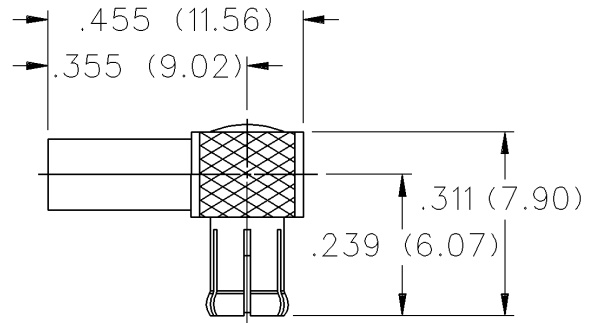
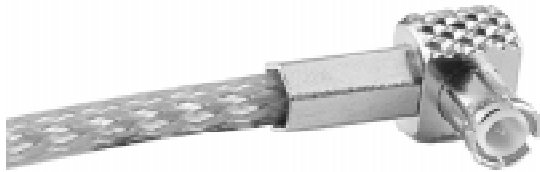

CABLE TYPE	GOLD PLATED
RG-316 DS, 188 DS	133-9404-101

MCX Crimp Type Right Angle Plugs For Flexible Cable

CABLE GROUP	PART NUMBER	"A"	"B"	"C"	CRIMP HEX
RG-316/u, 188, 174	133-9403-101	.050 (1.27)	.270 (6.86)	.200 (5.08)	.128 (3.25)
RG-316DS, 188DS	133-9404-101	.050 (1.27)	.270 (6.86)	.200 (5.08)	.151 (3.83)

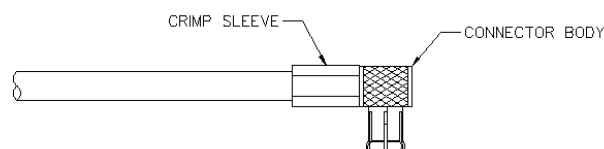
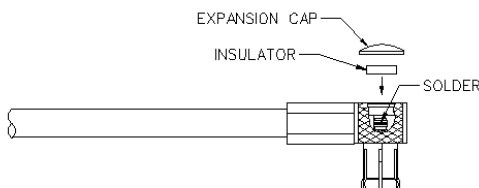
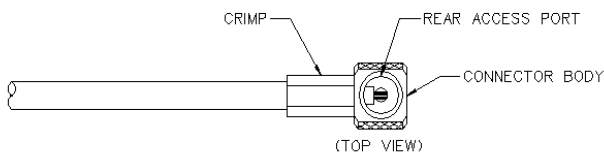
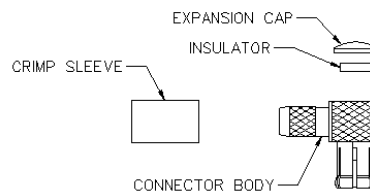
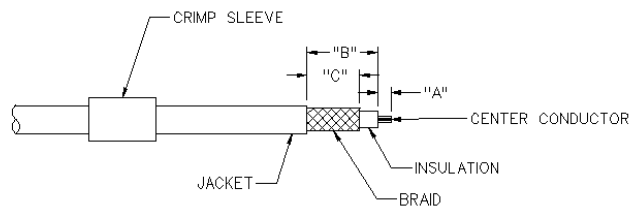

1. Identify connector parts. (4 piece parts)
2. Strip cable to dimensions shown. Do not nick braid or center conductor. A wire stripper of correct size is recommended for this step. Twist stranded center conductor into tight bundle and tin (optional). Slide crimp sleeve onto cable shown.
3. Flair braid and slide cable into body making certain that the cable insulation bottoms on center contact. Arrange braid uniformly around crimp stem. Slide crimp sleeve over braid and crimp securely using recommended crimp tool.
4. Solder center conductor to contact through rear access port. Use a minimum amount of solder for a full fillet joint. **.020 (0.51) diameter solder is recommended.**
5. Assemble insulator if applicable then place expansion cap in access port and seat with .156 (3.96) diameter flat punch or MCX hand assembly tool 141-0000-908. Shrink heat shrink tubing over crimp sleeve if applicable.

SPECIFICATIONS

ELECTRICAL RATINGS

Impedance: 50 Ohms

Frequency Range: 0-6 GHz

VSWR: (f = GHz)

	Straight Cabled Connectors	Right Angle Cabled Connectors
RG-316 cable	1.13 + .04f	1.07 + .04f
Uncabled receptacles	N/A	

Working Voltage: (Vrms maximum)†

Connectors for Cable Type	<u>Sea Level</u>	<u>70K Feet</u>
RG-316	335	85

Dielectric Withstanding Voltage: (VRMS minimum at sea level)

Connectors for RG-316, uncabled receptacles	1000
---	------

Corona Level: (Volts minimum at 70,000 feet)

Connectors for RG-316, uncabled receptacles	250
---	-----

Insertion Loss: (dB maximum, tested at 1 GHz)

Straight cable connectors	0.1 dB
Right angle cable connectors	0.2 dB
Uncabled receptacles	N/A

Insulation Resistance: 10,000 megohms minimum

Contact Resistance: (milliohms maximum)

	<u>Initial</u>	<u>After Environmental</u>
Center contact (straight cabled connectors, uncabled receptacles)	5.0	8.0
Center contact (right angle cabled connectors)	5.0	15.0
Outer contact	1.0	1.5
Braid to body	1.0	N/A

RF Leakage: (dB typical tested at 2.5 GHz)

Cable connectors	-55
Uncabled receptacles	N/A

RF High Potential Withstanding Voltage: (Vrms minimum, tested at 4 and 7 MHz)

Cabled connectors	700
Uncabled receptacles	600

MECHANICAL RATINGS

Engagement Design: Compatible with CECC 22220, Series MCX

Engagement Force: 5.6 pounds maximum axial force

Disengagement Force: 8 pounds maximum axial force, 1 pound min.

Contact Retention: 2.3 pounds min. axial force (captivated contacts)
1 inch-ounce min. torque (uncabled receptacles)

Cable Retention:	Axial Force* (pounds)	Torque (in-oz)
Connectors for RG316	20	N/A
Connectors for RG316DS	25	N/A

* or cable breaking strength whichever is less.

ENVIRONMENTAL RATINGS (Meets or exceed the applicable paragraph of MIL-PRF-39012)

Durability: 500 cycles minimum

Temperature Range: - 65°C to + 165°C

Thermal Shock: MIL-STD-202, Method 107, Condition F

Corrosion: MIL-STD-202, Method 101, Condition B

Shock: MIL-STD-202, Method 213, Condition B

Vibration: MIL-STD-202, Method 204, Condition B

Moisture Resistance: MIL-STD-202, Method 106